

TUBES ET RACCORDS EVACUATION DIAMETRE 32

Figure	C. Jardibric	Réf client	Gencod	Désignation	Référence	Cdt	Sur-emb
Tubes PVC évacuation NFE NFM1							
	7110011C		3283460040626	Barre de 1 ml tube PVC Ø 32 – <i>NFE - NFM1</i>		10	374
	7110013S		3283460040633	Barre de 2 ml tube PVC Ø 32 – <i>NFE - NFM1</i>		10	374
	7110017Y		3283460040657	Barre de 4 ml tube PVC Ø 32 – <i>NFE - NFM1</i>		10	374
Tubes PVC évacuation M1							
	7111011G		3283460079190	Barre de 1 ml tube PVC Ø 32 – <i>MI</i>		10	1070
	7111013X		3283460055446	Barre de 2 ml tube PVC Ø 32 – <i>MI</i>		10	1070
	7111017C		3283460055453	Barre de 4 ml tube PVC Ø 32 – <i>MI</i>		10	138
Coudes mâle-femelle Nicoll							
	8490001E		3283460060174	Coude mâle-femelle 20° - Ø 32	HCF2	10	100
	8490015R		3283460069801	Coude mâle-femelle 30° - Ø 32	HCF3	10	
	8490031Z		3283460058584	Coude mâle-femelle 45° - Ø 32	HCF4	10	200
	8490045L		3283460058645	Coude mâle-femelle 67°30 - Ø 32	HCF6	10	200
	8490061T		3283460058706	Coude mâle-femelle 87°30 - Ø 32	HCF8	10	200
Coudes mâle-femelle SFC/Jardibric							
	8921021K		3283460078292	Coude mâle-femelle 45° - Ø 32 – SFC – <i>NF</i>		10	120
	8921041Y		3283460080448	Coude mâle-femelle 67°30 - Ø 32 – SFC – <i>NF</i>		10	100
	8921061L		3283460078360	Coude mâle-femelle 87°30 - Ø 32 – SFC – <i>NF</i>		10	100
Coudes femelle-femelle Nicoll							
	8491201U		3283460060204	Coude femelle-femelle 20° - Ø 32	HCF22	10	100
	8491215G		3283460071712	Coude femelle-femelle 30° - Ø 32	HCF33	10	
	8491231P		3283460059352	Coude femelle-femelle 45° - Ø 32	HCF44	10	200
	8491245B		3283460059413	Coude femelle-femelle 67°30 - Ø 32	HCF66	10	200
	8491261J		3283460059475	Coude femelle-femelle 87°30 – Ø 32	HCF88	10	180
	8491154U		3283460059765	Coude femelle-femelle 87°30 à joint – Ø 32	HCF88J	10	120
Coudes femelle-femelle SFC/Jardibric							
	8921101C		3283460078421	Coude femelle-femelle 45° - Ø 32 – SFC – <i>NF</i>		10	100
	8921121Q		3283460080493	Coude femelle-femelle 67°30 - Ø 32 – SFC – <i>NF</i>		10	90
	8921141D		3283460078490	Coude femelle-femelle 87°30 – Ø 32 – SFC – <i>NF</i>		10	80
Culottes et tés mâle-femelle Nicoll							
	8490101K		3283460058768	Té pied de biche mâle-femelle 87°30 - Ø 32	HTF188MF	10	100
	8491275W		3283460060181	Té pied de biche mâle-femelle 87°30 GR	HTF18	10	60
	8490145R		3283460058805	Culotte mâle-femelle 45° - Ø 32	HBF14	10	100
	8490161Z		3283460069955	Culotte mâle-femelle 67°30 – Ø 32	HBF16	10	100
	8490175L		3283460058867	Culotte mâle-femelle 87°30 – Ø 32	HBF18	10	100
Culottes mâle-femelle SFC/Jardibric							
	8921201H		3283460080530	Culotte mâle-femelle 45° - Ø 32 – SFC – <i>NF</i>		10	50

TUBES ET RACCORDS EVACUATION DIAMETRE 32

Figure	C. Jardibric	Réf client	Gencod	Désignation	Référence	Cdt	Sur-emb
--------	--------------	------------	--------	-------------	-----------	-----	---------

Culottes et tés femelle-femelle **Nicoll**



8491301A			3283460059536	Té pied de biche fem-fem 87°30 – Ø 32	HTF188	10	120
8491345G			3283460059567	Culotte femelle-femelle 45° - Ø 32	HBF144	10	100
8491361P			3283460071743	Culotte femelle-femelle 67°30 – Ø 32	HBF166	10	250
8491375B			3283460059628	Culotte femelle-femelle 87°30 – Ø 32	HBF188	10	100

Culottes et tés femelle-femelle **SFC/Jardibric**



8921261X			3283460078636	Culotte femelle-femelle 45° - Ø 32 – SFC – <i>NF</i>		10	50
8921162Z			3283460078544	Té PDB femelle-femelle 87°30 – Ø 32 – SFC		10	60

Douilles – Réductions **Nicoll**



8491045Q			3283460059246	Douille collet mince pour écrou 32 - 33x42	HDDF	10	200
8491061Y			3283460059253	Réduction femelle-femelle pour HDDF	HR2DF	10	250
8491065D			3283460059741	Douille femelle Ø 32 écrou 33x42	HDEFF	10	100
8491031D			3283460059215	Réduction métal-plastique 32-12x22	HRMPF	10	150

Manchons – Bouchons **Nicoll**



8491175Q			3283460059680	Manchon femelle-femelle à butée – Ø 32	HM2F	10	300
8492001N			3283460069924	Manchette mâle-femelle – Ø 32	HZF	10	200
8492315R			3283460071798	Coullisse femelle-femelle – Ø 32	HKF	10	250
8491076S			3283460059789	Manchette à joint femelle-femelle – Ø 32	HMAF2J	10	100
8490201Q			3283460058928	Manchon de dilatation mâle-femelle – Ø 32	HMF	10	100
8492015A			3283460069986	Manchon de dilatation horizontal MF Ø 32	HMFH	10	80
8491001J			3283460059154	Bouchon de dégorgement Ø 32	HFF	10	200
8491075K			3283460059277	Adaptateur pour bouchon Ø 32	HMFA3	10	300
8466302U			3309032406505	Manchette réparation mâle Ø 32	UZFF	10	

Manchons – Bouchons **SFC/Jardibric**



8921381Q			3283460080776	Manchon femelle-femelle à butée – Ø 32 – SFC – <i>NF</i>		10	240
8921421G			3283460078711	Bouchon de dégorgement Ø 32 – SFC		10	120





Manchette souple **Nicoll**

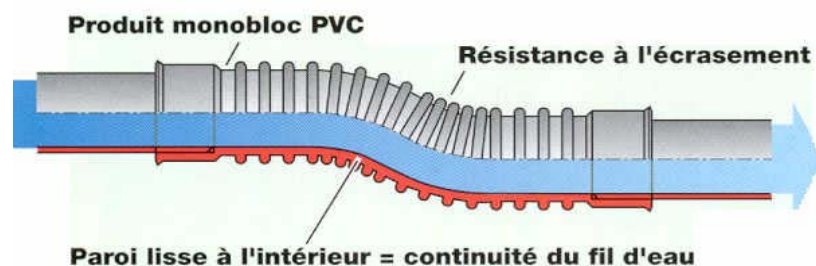

8171560E			3309032205207	Manchette souple Ø 32 FF	FLEXF	8	64
8171570L			3309032463706	Manchette souple Ø 32 MF	FLEXFM	8	64



TUBES ET RACCORDS EVACUATION DIAMETRE 32

Figure	C. Jardibric	Réf client	Gencod	Désignation	Référence	Cdt	Sur-emb
Siphons – Sortie de lavabo Nicoll							
	8341015C		3309030470300	Siphon à coller entrée verticale Ø 32	YFC	1	100
	8341065K		3309030470508	Siphon à coller entrée horizontale Ø 32	YFIC	1	100
Sortie de lavabo SFC							
	<u>7751810T</u>		<u>3283460091413</u>	<u>Sortie lavabo Ø 32 – SFC</u>	<i>nouveauté</i>	<u>1</u>	
Clapet Nicoll							
	8341670L		3309032361804	Clapet anti-retour pour évacuation Ø 32	CASF4	1	
Clapet de retenue -Aérateur à membrane SFC/Jardibric							
	8561588J		3283460090683	Clapet de retenue Ø 32 – SFC		1	
	<u>7752000Y</u>		<u>3283460091437</u>	<u>Aérateur à membrane mâle Ø 32-40-50 – SFC</u>	<i>nouveauté</i>	<u>1</u>	
Manchon d'adaptation EPDM							
	7661001C		3283460063472	Manchon égal Ø 24 à 32		10	

Nos raccords d'adaptation pour tubes d'évacuation s'adaptent sur toutes sortes de tubes :
PVC, inox, cuivre, acier, fonte, galva,...



Accessoires de pose Nicoll

	8353624W		3309030240705	Collier lyre Ø 32	UCO32	50	1800
	8355111Y		3309031037403	Sachet de 5 colliers lyres + attaches Ø 32	5CA32	1	
	8353502M		3309030491503	Collier monobloc Ø 32	UCM32	50	
	8355002T		3309031036604	Sachet de 5 colliers monoblocs Ø 32	5CM32	1	

Accessoires de pose SFC/Jardibric

	8925500J		3283460080059	Collier PVC Ø 32 avec clips – SFC		10	
	8925501R		3283460088864	Sachet de 10 colliers lyre Ø 32 – SFC		1	

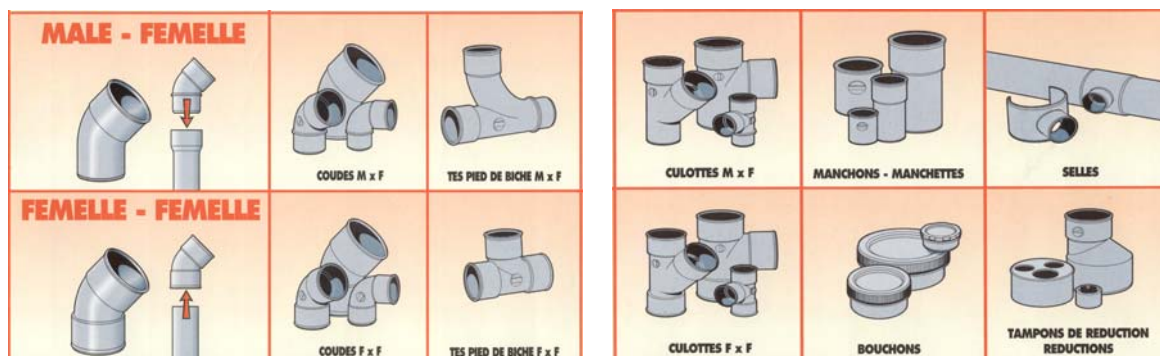

TUBES ET RACCORDS EVACUATION DIAMETRE 40

Figure	C. Jardibric	Réf client	Gencod	Désignation	Référence	Cdt	Sur-emb
--------	--------------	------------	--------	-------------	-----------	-----	---------

Tubes PVC évacuation NFE NFM1



7110031Q			3283460040664	Barre de 1 ml tube PVC Ø 40 - <i>NFE - NFM1</i>		10	248
7110033F			3283460040671	Barre de 2 ml tube PVC Ø 40 - <i>NFE - NFM1</i>		10	248
7110037L			3283460040695	Barre de 4 ml tube PVC Ø 40 - <i>NFE - NFM1</i>		10	248

Tubes PVC évacuation M1



7111031U			3283460079206	Barre de 1 ml tube PVC Ø 40 - <i>MI</i>		10	743
7111033K			3283460055460	Barre de 2 ml tube PVC Ø 40 - <i>MI</i>		10	743
7111037Q			3283460055477	Barre de 4 ml tube PVC Ø 40 - <i>MI</i>		10	138

Coudes mâle-femelle **Nicoll**



8490002M			3283460058577	Coude mâle-femelle 20° - Ø 40	HCH2	10	150
8490016Z			3283460069818	Coude mâle-femelle 30° - Ø 40	HCH3	10	120
8490032G			3283460058591	Coude mâle-femelle 45° - Ø 40	HCH4	10	150
8490046T			3283460058652	Coude mâle-femelle 67°30 - Ø 40	HCH6	10	120
8490062B			3283460058713	Coude mâle-femelle 87°30 - Ø 40	HCH8	10	200

Coudes mâle-femelle **SFC/Jardibric**



<u>8921002E</u>			<u>3283460091475</u>	<u>Coude mâle-femelle 22°30 - Ø 40 - SFC</u>	<i>nouveauté</i>	<u>10</u>	
8921022S			3283460078308	Coude mâle-femelle 45° - Ø 40 - SFC - <i>NF</i>		10	100
8921042F			3283460080455	Coude mâle-femelle 67°30 - Ø 40 - SFC - <i>NF</i>		10	120
8921062T			3283460078377	Coude mâle-femelle 87°30 - Ø 40 - SFC - <i>NF</i>		10	100

Coudes femelle-femelle **Nicoll**



8491202C			3283460059345	Coude femelle-femelle 20° - Ø 40	HCH22	10	150
8491216P			3283460071729	Coude femelle-femelle 30° - Ø 40	HCH33	10	120
8491232X			3283460059369	Coude femelle-femelle 45° - Ø 40	HCH44	10	120
8491246J			3283460059420	Coude femelle-femelle 67°30 - Ø 40	HCH66	10	120
8491262R			3283460059482	Coude femelle-femelle 87°30 - Ø 40	HCH88	10	200
8491158A			3283460059772	Coude femelle-femelle 87°30 à joint - Ø 40	HCH88J	10	100

Coudes femelle-femelle **SFC/Jardibric**



<u>8921082G</u>			<u>3283460091451</u>	<u>Coude femelle-femelle 22°30 - Ø 40 - SFC</u>	<i>nouveauté</i>	<u>10</u>	
8921102K			3283460078438	Coude femelle-femelle 45° - Ø 40 - SFC - <i>NF</i>		10	140
8921122Y			3283460078476	Coude femelle-femelle 67°30 - Ø 40 - SFC - <i>NF</i>		10	130
8921142L			3283460078506	Coude femelle-femelle 87°30 - Ø 40 - SFC - <i>NF</i>		10	100

Culottes et tés mâle-femelle **Nicoll**



8490102S			3283460058775	Té pied de biche mâle-femelle 87°30 - Ø 40	HTH188MF	10	70
8491276D			3283460060198	Té pied de biche mâle-femelle 87°30 GR	HTH18	10	80
8490146Z			3283460058812	Culotte mâle-femelle 45° - Ø 40	HBH14	10	50
8490162G			3283460062413	Culotte mâle-femelle 67°30 - Ø 40	HBH16	10	50
8490176T			3283460058874	Culotte mâle-femelle 87°30 - Ø 40	HBH18	10	50

Culottes et tés mâle-femelle **SFC/Jardibric**











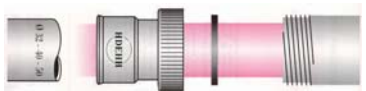

8921202Q			3283460080547	Culotte mâle-femelle 45° - Ø 40 - SFC - <i>NF</i>		10	60
8921242R			3283460080714	Culotte mâle-femelle 87°30 - Ø 40 - SFC - <i>NF</i>		10	70

Culottes et tés femelle-femelle **Nicoll**



8491302H			3283460059543	Té pied de biche femelle-femelle 87°30 - Ø 40	HTH188	10	130
8493601A			3283460071781	Té pied de biche fem-fem 87°30 - Ø 40-32	HTH288	10	70
8491346P			3283460059574	Culotte femelle-femelle 45° - Ø 40	HBH144	10	50
8491362X			3283460062406	Culotte femelle-femelle 67°30 - Ø 40	HBH166	10	140
8491376J			3283460059635	Culotte femelle-femelle 87°30 - Ø 40	HBH188	10	50
8492401K			3283460071774	Culotte femelle-femelle 87°30 - Ø 40-32	HBH288	10	30



TUBES ET RACCORDS EVACUATION DIAMETRE 40

Figure	C. Jardibric	Réf client	Gencod	Désignation	Référence	Cdt	Sur-emb
Culottes et tés femelle-femelle SFC/Jardibric							
	8921262E		3283460078643	Culotte femelle-femelle 45° - Ø 40 - SFC - NF		10	100
	8921164P		3283460078551	Té PDB femelle-femelle 87°30 - Ø 40 - SFC		10	55
Douilles - Réductions Nicoll							
	8491046Y		3283460059338	Douille collet mince pour écrou 40-40x49	HDDH	10	100
	8491062F		3283460059260	Réduction femelle-femelle pour HDDH	HR2DH	10	
	8491066L		3283460059758	Douille femelle Ø 40 écrou 40x49	HDEHH	10	70
HDEHH							HR2DH
Douilles - Réductions SFC/Jardibric							
	8925271W		3283460078865	Douille femelle Ø 40 écrou 40x49 - SFC		10	100
Manchette souple Nicoll							
	8171561M		3309031404007	Manchette souple Ø 40 FF	FLEXH	8	64
	8171571T		3309032463805	Manchette souple Ø 40 MF	FLEXHM	8	64
Manchons - Bouchons Nicoll							
	8491176Y		3283460059697	Manchon femelle-femelle à butée - Ø 40	HM2H	10	180
	8492002W		3283460069931	Manchette mâle-femelle - Ø 40	HZH	10	
	8492316Z		3283460071804	Coulisse femelle-femelle - Ø 40	HKH	10	200
	8491078H		3283460059796	Manchette à joint femelle-femelle - Ø 40	HMAH2J	10	100
	8490202Y		3283460058935	Manchon de dilatation mâle-femelle - Ø 40	HMH	10	60
	8492016H		3283460069993	Manchon de dilatation horizontal MF Ø 40	HMHH	10	50
	8491002R		3283460059161	Bouchon de dégorgement Ø 40	HFH	10	200
	8491077A		3283460059284	Adaptateur pour bouchon Ø 40 Fem Ø 40	HMFA4	10	100
	8466304K		3309032406604	Manchette réparation mâle Ø 40	UZHH	10	150
Manchons - Bouchons SFC/Jardibric							
	8921382Y		3283460080783	Manchon femelle-femelle à butée - Ø 40 - SFC - NF		10	120
	8921442C		3283460091390	Manchon de dilatation mâle-femelle-Ø40-SFC	nouveauté	10	
	8921422P		3283460078728	Bouchon de dégorgement Ø 40 - SFC		10	180
Réductions Nicoll							
	8490252F		3283460058980	Réduction incorporée mâle-femelle Ø 40/32	HIH	10	200
	8490301W		3283460059000	Réduction extérieure excentrée MF Ø 40/32	HIH1	10	80
	8491032L		3283460059222	Réduction métal-plastique 40-12x30	HRMPH	10	120
Réductions SFC/Jardibric							
	8922313P		3283460081421	Réduction incorporée mâle-femelle Ø 40/32 - SFC		10	40
	8921602M		3283460078803	Réduction extérieure excentrée MF Ø 40/32 - SFC		10	45

TUBES ET RACCORDS EVACUATION DIAMETRE 40

Figure	C. Jardibric	Réf client	Gencod	Désignation	Référence	Cdt	Sur-emb
Siphons – Sortie de lavabo Nicoll							
	8341030C		3309030471109	Siphon à coller entrée verticale Ø 40	YHC	1	70
	8341080K		3309030471307	Siphon à coller entrée horizontale Ø 40	YH1C	1	70
Sortie de lavabo SFC/Jardibric							
	<u>7751811B</u>		<u>3283460091420</u>	<u>Sortie lavabo Ø 40 – SFC</u>	<i>nouveauté</i>	<u>1</u>	
Clapet Nicoll							
	8341671T		3309032361903	Clapet anti-retour pour évacuation Ø 40	CASH4	1	100
Clapet de retenue - Aérateur à membrane SFC/Jardibric							
	8561689X		3283460090690	Clapet de retenue Ø 40 – SFC		1	
		<u>7752000Y</u>		<u>3283460091437</u>	<u>Aérateur à membrane mâle Ø 32-40-50 – SFC</u>	<i>nouveauté</i>	<u>1</u>
Manchon d'adaptation EPDM							
	7661003S		3283460063496	Manchon égal Ø 32 à 40		10	
	7661002K		3283460063489	Manchon réduit Ø 24 à 32 / 32 à 40		10	
Siphons de machine à laver Nicoll							
	8341382R		3309032593205	Siphon simple à sortie horizontale	1YH42C	1	10
Siphons de machine à laver SFC/Jardibric							
	8320200H		3283460082121	Siphon simple à sortie horizontale Ø 40 – SFC		1	
	8320203F		3283460082510	Siphon simple à sortie verticale Ø 40 – SFC		1	
	8320210P		3283460082527	Entonnoir d'évacuation double Ø 40 – SFC		1	
 <p>CLAPET ANTI-RETOUR Evite le reflux des eaux usées</p> <p>Siphon de machine à laver double - Sortie horizontale</p> <p>Siphon de machine à laver simple. Sortie horizontale</p>							
Accessoires de pose Nicoll							
	8353630X		3309030241009	Collier lyre Ø 40	UCO40	50	1500
	8355114W		3309031037502	Sachet de 5 colliers lyres + attaches Ø 40	5CA40	1	120
	8353504C		3309030491602	Collier monobloc Ø 40	UCM40	50	100
	8355004J		3309031036703	Sachet de 5 colliers monoblocs Ø 40	5CM40	1	80
Accessoires de pose SFC/Jardibric							
	8925502Z		3283460080066	Collier PVC Ø 40 avec clips – SFC		10	
	8925503G		3283460088871	Sachet de 10 colliers lyre Ø 40 – SFC		1	

TUBES ET RACCORDS EVACUATION DIAMETRE 50

Figure	C. Jardibric	Réf client	Gencod	Désignation	Référence	Cdt	Sur-emb
Tubes PVC évacuation NFE NFMI							
	7110051D		3283460040701	Barre de 1 ml tube PVC Ø 50 - <i>NFE - NFMI</i>		10	172
	7110053T		3283460040718	Barre de 2 ml tube PVC Ø 50 - <i>NFE - NFMI</i>		10	172
	7110057Z		3283460040732	Barre de 4 ml tube PVC Ø 50 - <i>NFE - NFMI</i>		10	172
Tubes PVC évacuation MI							
	7111051H		3283460079213	Barre de 1 ml tube PVC Ø 50 - <i>MI</i>		10	452
	7111053Y		3283460055484	Barre de 2 ml tube PVC Ø 50 - <i>MI</i>		10	452
	7111057D		3283460055491	Barre de 4 ml tube PVC Ø 50 - <i>MI</i>		10	129
Coudes mâle-femelle Nicoll							
	8490003U		3283460062383	Coude mâle-femelle 20° - Ø 50	HCJ2	10	80
	8490017G		3283460069825	Coude mâle-femelle 30° - Ø 50	HCJ3	10	
	8490033P		3283460058607	Coude mâle-femelle 45° - Ø 50	HCJ4	10	60
	8490047B		3283460058669	Coude mâle-femelle 67°30' - Ø 50	HCJ6	10	60
	8490063J		3283460058720	Coude mâle-femelle 87°30' - Ø 50	HCJ8	10	60
Coudes mâle-femelle SFC/Jardibric							
	<u>8921003M</u>		<u>3283460091482</u>	<u>Coude mâle-femelle 22°30' - Ø 50 - SFC</u>	<u>nouveauté</u>	<u>10</u>	
	8921023A		3283460078315	Coude mâle-femelle 45° - Ø 50 - SFC - <i>NF</i>		10	80
	8921043N		3283460080462	Coude mâle-femelle 67°30' - Ø 50 - SFC - <i>NF</i>		10	70
	8921063B		3283460078384	Coude mâle-femelle 87°30' - Ø 50 - SFC - <i>NF</i>		10	60
Coudes femelle-femelle Nicoll							
	8491203K		3283460071699	Coude femelle-femelle 20° - Ø 50	HCJ22	10	80
	8491217X		3283460071736	Coude femelle-femelle 30° - Ø 50	HCJ33	10	
	8491233E		3283460059376	Coude femelle-femelle 45° - Ø 50	HCJ44	10	60
	8491247R		3283460059437	Coude femelle-femelle 67°30' - Ø 50	HCJ66	10	60
	8491263Z		3283460059499	Coude femelle-femelle 87°30' - Ø 50	HCJ88	10	100
Coudes femelle-femelle SFC/Jardibric							
	<u>8921083P</u>		<u>3283460091468</u>	<u>Coude femelle-femelle 22°30' - Ø 50 - SFC</u>	<u>nouveauté</u>	<u>10</u>	
	8921103S		3283460078445	Coude femelle-femelle 45° - Ø 50 - SFC - <i>NF</i>		10	90
	8921123F		3283460080509	Coude femelle-femelle 67°30' - Ø 50 - SFC - <i>NF</i>		10	70
	8921143T		3283460078513	Coude femelle-femelle 87°30' - Ø 50 - SFC - <i>NF</i>		10	100
Culottes et tés mâle-femelle Nicoll							
	8490103A		3283460071859	Té pied de biche mâle-femelle 87°30' GR	HTJ18	10	70
	8490147G		3283460058829	Culotte mâle-femelle 45° - Ø 50	HBJ14	10	30
	8490177B		3283460058881	Culotte mâle-femelle 87°30' - Ø 50	HBJ18	10	30
Culottes et tés femelle-femelle Nicoll							
	8491303Q		3283460059550	Té pied de biche femelle-femelle 87°30' - Ø 50	HTJ188	10	70
	8491347X		3283460059581	Culotte femelle-femelle 45° - Ø 50	HBJ144	10	30





TUBES ET RACCORDS EVACUATION DIAMETRE 50

Figure	C. Jardibric	Réf client	Gencod	Désignation	Référence	Cdt	Sur-emb
--------	--------------	------------	--------	-------------	-----------	-----	---------



Culottes et tés femelle-femelle **SFC/Jardibric**

	8921263M		3283460078650	Culotte femelle-femelle 45° - Ø 50 - SFC - NF		10	30
	8921166E		3283460078568	Té PDB femelle-femelle 87°30 - Ø 50 - SFC		10	45

Manchons - Bouchons **Nicoll**

	8491177F		3283460059703	Manchon femelle-femelle à butée - Ø 50	HM2J	10	100
	8491080D		3283460059802	Manchette à joint femelle-femelle - Ø 50	HMAJ2J	10	
	8490203F		3283460058942	Manchon de dilatation mâle-femelle - Ø 50	HMJ	10	40
	8491003Z		3283460059178	Bouchon de dégorgeement Ø 50	HFJ	10	150
	8491079Q		3283460059291	Adaptateur pour bouchon Ø 50 Fem Ø 50	HMFA5	10	

Manchons - Bouchons **SFC/Jardibric**

	8921383F		3283460078674	Manchon femelle-femelle à butée - Ø 50 - SFC - NF		10	100
	<u>8921443K</u>		<u>3283460091512</u>	<u>Manchon de dilatation mâle-femelle-Ø50-SFC</u>	<u>nouveauté</u>	<u>10</u>	
	8921423X		3283460078735	Bouchon de dégorgeement Ø 50 - SFC		10	90



Manchette souple **Nicoll**

	8171562U		3309032205306	Manchette souple Ø 50 FF	FLEXJ	8	64
	8171572B		3309032463904	Manchette souple Ø 50 MF	FLEXJM	8	64

Réductions **Nicoll**

	8490254W		3283460058997	Réduction incorporée mâle-femelle Ø 50/40	HIJ	10	100
	8490253N		3283460069849	Réduction incorporée mâle-femelle Ø 50/32	HIJF	10	300
	8490304T		3283460059017	Réduction extérieure excentrée MF Ø 50/40	HIJ1	10	
	8490303L		3283460059024	Réduction extérieure excentrée MF Ø 50/32	HIJ2	10	

Réductions **SFC/Jardibric**

	8922314X		3283460080851	Réduction incorporée mâle-femelle Ø 50/32 - SFC		10	40
	8922315E		3283460078858	Réduction incorporée mâle-femelle Ø 50/40 - SFC		10	60
	8921470G		3283460080653	Réduction extérieure excentrée MF Ø 50/32 - SFC		10	70
	8921603U		3283460080646	Réduction extérieure excentrée MF Ø 50/40 - SFC		10	60

Manchon d'adaptation EPDM

	7661005H		3283460063519	Manchon égal Ø 40 à 50		10	
	7661004A		3283460063502	Manchon réduit Ø 40 à 50 / Ø 32 à 40		10	



Nos raccords d'adaptation pour tubes d'évacuation s'adaptent sur toutes sortes de tubes :
PVC, inox, cuivre, acier, fonte, galva,...



Clapet de retenue **SFC/Jardibric**

<u>7752000Y</u>		<u>3283460091437</u>	<u>Aérateur à membrane mâle Ø 32-40-50 - SFC</u>	<u>nouveauté</u>	<u>I</u>		
-----------------	--	----------------------	--------------------------------------------------	------------------	----------	--	--

Accessoires de pose **Nicoll**

	8353636S		3309030241306	Collier lyre Ø 50	UCO50	50	1200
	8355117T		3309031037601	Sachet de 5 colliers lyres + attaches Ø 50	5CA50	1	200
	8353506S		3309030491701	Collier monobloc Ø 50	UCM50	50	
	8355006Z		3309031036802	Sachet de 5 colliers monoblocs Ø 50	5CM50	1	50

Accessoires de pose **SFC/Jardibric**

	8925504P		3283460080073	Collier PVC Ø 50 avec clips - SFC		10	
	8925505X		3283460088888	Sachet de 10 colliers lyre Ø 50 - SFC		1	

TUBES ET RACCORDS EVACUATION DIAMETRE 63

Figure	C. Jardibric	Réf client	Gencod	Désignation	Référence	Cdt	Sur-emb
--------	--------------	------------	--------	-------------	-----------	-----	---------

Tubes PVC évacuation NFE NFMI



7110071R			3283460040749	Barre de 1 ml tube PVC Ø 63 - NFE - NFMI		5	170
7110073G			3283460040756	Barre de 2 ml tube PVC Ø 63 - NFE - NFMI		5	170
7110077M			3283460040770	Barre de 4 ml tube PVC Ø 63 - NFE - NFMI		5	170

Coudes mâle-femelle Nicoll



8461108H			3309030515407	Coude mâle-femelle 45° - Ø 63	UCL4	1	70
8461158Q			3309030515605	Coude mâle-femelle 67°30' - Ø 63	UCL6	1	45
8461208N			3309030515803	Coude mâle-femelle 87°30' - Ø 63	UCL8	1	40

Coudes femelle-femelle Nicoll



8471108L			3309030515506	Coude femelle-femelle 45° - Ø 63	UCL44	1	45
8471158T			3309030515704	Coude femelle-femelle 67°30' - Ø 63	UCL66	1	80
8471208R			3309030515902	Coude femelle-femelle 87°30' - Ø 63	UCL88	1	35

Culottes femelle-femelle Nicoll



8472007C			3309030516107	Culotte femelle-femelle 45° - Ø 63	UBL144	1	18
8473007G			3309030516305	Culotte femelle-femelle 87°30' - Ø 63	UBL188	1	20

Accessoires divers Nicoll



8476108H			3309030516404	Manchon femelle-femelle à butée - Ø 63	UM2L	1	60
8465362E			3309030516800	Réduction incorporée mâle-femelle Ø 63/40	UL4	1	300
8465361X			3309030516701	Réduction incorporée mâle-femelle Ø 63/50	UL5	1	300
8465208F			3309030727107	Réduction extérieure excentrée MF Ø 63/50	UIL1	1	80
8465708H			3309030516602	Bouchon de dégorgement Ø 63	UFL	1	140
8353642T			3309030241900	Collier lyre Ø 63	UCO63	25	
8353508H			3283460059864	Collier à bride Ø 63	UCOL	25	
8355030Y			3309031036901	5 colliers à bride Ø 63	5COL	1	

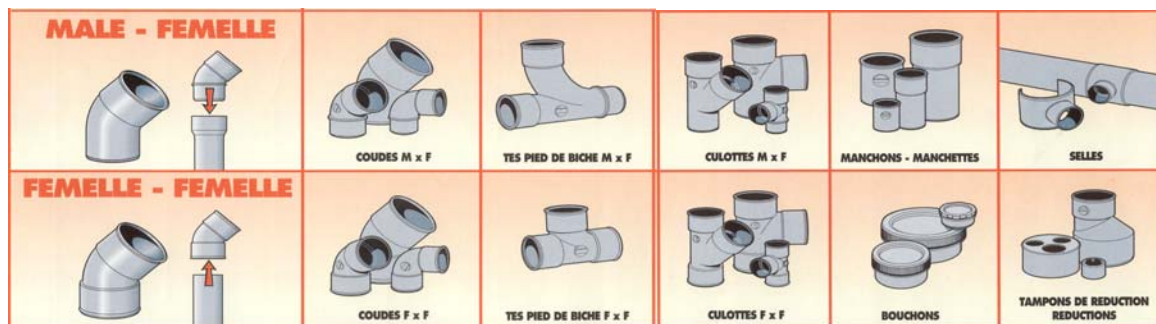

TUBES ET RACCORDS EVACUATION DIAMETRE 80

Figure	C. Jardibric	Réf client	Gencod	Désignation	Référence	Cdt	Sur-emb
Tubes PVC évacuation NFE NFMI							
	7110111H		3283460040824	Barre de 1 ml tube PVC Ø 80 - <i>NFE - NFMI</i>		5	203
	7110113Y		3283460040831	Barre de 2 ml tube PVC Ø 80 - <i>NFE - NFMI</i>		5	203
	7110117D		3283460040855	Barre de 4 ml tube PVC Ø 80 - <i>NFE - NFMI</i>		5	203
Tubes PVC évacuation M1							
	7111111M		3283460079220	Barre de 1 ml tube PVC Ø 80 - <i>MI</i>		5	203
	7111113C		3283460055507	Barre de 2 ml tube PVC Ø 80 - <i>MI</i>		5	203
	7111117H		3283460055514	Barre de 4 ml tube PVC Ø 80 - <i>MI</i>		5	203
Coudes mâle-femelle Nicoll							
	8490036M		3283460058614	Coude mâle-femelle 45° - Ø 80	HCR4	1	65
	8490050E		3283460058676	Coude mâle-femelle 67°30 - Ø 80	HCR6	1	50
	8490066G		3283460058737	Coude mâle-femelle 87°30 - Ø 80	HCR8	1	40
Coudes mâle-femelle SFC/Jardibric							
	8921026Y		3283460078322	Coude mâle-femelle 45° - Ø 80 - SFC		1	25
	8921046L		3283460080127	Coude mâle-femelle 67°30 - Ø 80 - SFC		1	20
	8921066Z		3283460078391	Coude mâle-femelle 87°30 - Ø 80 - SFC		1	20
Coudes femelle-femelle Nicoll							
	8491236C		3283460059383	Coude femelle-femelle 45° - Ø 80	HCR44	1	50
	8491250U		3283460059451	Coude femelle-femelle 67°30 - Ø 80	HCR66	1	40
	8491266X		3283460059505	Coude femelle-femelle 87°30 - Ø 80	HCR88	1	35
Coudes femelle-femelle SFC/Jardibric							
	8921106Q		3283460078452	Coude femelle-femelle 45° - Ø 80 - SFC		1	20
	8921126D		3283460080141	Coude femelle-femelle 67°30 - Ø 80 - SFC		1	20
	8921146R		3283460078520	Coude femelle-femelle 87°30 - Ø 80 - SFC		1	20
Culottes mâle-femelle Nicoll							
	8490150K		3283460058836	Culotte mâle-femelle 45° - Ø 80	HBR14	1	24
	8490180E		3283460058898	Culotte mâle-femelle 87°30 - Ø 80	HBR18	1	30
Culottes et tés mâle-femelle SFC/Jardibric							
	8921206W		3283460078575	Culotte mâle-femelle 45° - Ø 80 - SFC		1	20
	8921246X		3283460078605	Tés mâle-femelle 87°30 - Ø 80 - SFC		1	25
Culottes femelle-femelle Nicoll							
	8491350A		3283460059598	Culotte femelle-femelle 45° - Ø 80	HBR144	1	20
	8491380U		3283460059659	Culotte femelle-femelle 87°30 - Ø 80	HBR188	1	20
Culottes femelle-femelle SFC/Jardibric							
	8921266K		3283460080721	Culotte femelle-femelle 45° - Ø 80 - SFC		1	40
	8921306B		3283460079251	Culotte femelle-femelle 87°30 - Ø 80 - SFC		1	25
Manchons – Bouchons – Réductions Nicoll							
	8491180J		3283460060211	Manchon femelle-femelle à butée - Ø 80	HM2R	1	40
	8490206D		3283460058959	Manchon de dilatation mâle-femelle - Ø 80	HMR	1	40
	8491006X		3283460059185	Bouchon de dégorgeement Ø 80	HFR	1	80
	8490515T		3283460059086	Réduction incorporée mâle-femelle Ø 80/32	HR3	1	
	8490516B		3283460059079	Réduction incorporée mâle-femelle Ø 80/40	HR4	1	80
	8490517J		3283460059062	Réduction incorporée mâle-femelle Ø 80/50	HR5	1	80

TUBES ET RACCORDS EVACUATION DIAMETRE 80

Figure	C. Jardibric	Réf client	Gencod	Désignation	Référence	Cdt	Sur-emb
--------	--------------	------------	--------	-------------	-----------	-----	---------

Manchons – Bouchons – Réductions SFC/Jardibric



8921386D			3283460078681	Manchon femelle-femelle à butée – Ø 80 – SFC		1	30
<u>8921446H</u>			<u>3283460091529</u>	<u>Manchon de dilatation mâle-femelle-Ø80-SFC</u>	<u>nouveauté</u>	<u>1</u>	
8921426U			3283460078742	Bouchon de dégorgement Ø 80 – SFC		1	60
8922025U			3283460081438	Réduction extérieure excentrée mâle-femelle Ø 80/32 – SFC		1	40
8922026C			3283460080165	Réduction extérieure excentrée mâle-femelle Ø 80/40 – SFC		1	40
8922027K			3283460080219	Réduction extérieure excentrée mâle-femelle Ø 80/50 – SFC		1	40

Accessoires divers Nicoll













8353646Z			3309030242600	Collier lyre Ø 80	UCO80	25	450
8355061A			3309031037106	Sachet de 2 colliers à bride Ø 80	2COR	1	50
8355172U			3309031037908	Sachet de 2 colliers lyre + attaches Ø 80	2CA80	1	

Accessoires divers SFC/Jardibric



8925509C			3283460088840	Sachet de 2 colliers à bride Ø 80 – SFC			
8925510Q			3283460088895	Sachet de 2 colliers lyre Ø 80 – SFC			

TUBES ET RACCORDS EVACUATION DIAMETRE 100

Figure	C. Jardibric	Réf client	Gencod	Désignation	Référence	Cdt	Sur-emb
Tubes PVC évacuation NFE NFM1							
	7110151J		3283460040909	Barre de 1 ml tube PVC Ø 100 – <i>NFE – NFM1</i>		5	126
	7110153Z		3283460040916	Barre de 2 ml tube PVC Ø 100 - <i>NFE – NFM1</i>		5	126
	7110157E		3283460040930	Barre de 4 ml tube PVC Ø 100 - <i>NFE – NFM1</i>		5	126
Tubes PVC évacuation M1							
	7111151N		3283460075956	Barre de 1 ml tube PVC Ø 100 – <i>MI</i>		5	137
	7111153D		3283460055699	Barre de 2 ml tube PVC Ø 100 – <i>MI</i>		5	137
	7111157J		3283460055712	Barre de 4 ml tube PVC Ø 100 – <i>MI</i>		5	137
Coudes mâle-femelle Nicoll							
	8490008H		3283460062390	Coude mâle-femelle 20° - Ø 100	HCT2	1	45
	8490022A		3283460069832	Coude mâle-femelle 30° - Ø 100	HCT3	1	45
	8490038C		3283460058621	Coude mâle-femelle 45° - Ø 100	HCT4	1	70
	8490052U		3283460058683	Coude mâle-femelle 67°30 - Ø 100	HCT6	1	55
	8490068X		3283460058744	Coude mâle-femelle 87°30 - Ø 100	HCT8	1	45
Coudes mâle-femelle SFC/Jardibric							
	8921008A		3283460080660	Coude mâle-femelle 20° - Ø 100 – SFC		1	30
	8921028N		3283460078339	Coude mâle-femelle 45° - Ø 100 – SFC – <i>NF</i>		1	50
	8921048B		3283460078353	Coude mâle-femelle 67°30 - Ø 100 – SFC – <i>NF</i>		1	20
	8921068P		3283460078407	Coude mâle-femelle 87°30 - Ø 100 – SFC – <i>NF</i>		1	35
Secteurs de coude mâle-femelle Nicoll							
	8490122F		3283460058782	Secteur de coude mâle-femelle 15° Ø 100	HST1	1	40
	8490138H		3283460058799	Secteur de coude mâle-femelle 30° Ø 100	HST3	1	30
Secteurs de coude mâle-femelle SFC/Jardibric							
	8921528Q		3283460078773	Secteur de coude mâle-femelle 15° Ø 100 – SFC		1	35
	8921548D		3283460078780	Secteur de coude mâle-femelle 30° Ø 100 – SFC		1	45
Coudes femelle-femelle Nicoll							
	8491208Y		3283460071705	Coude femelle-femelle 20° - Ø 100	HCT22	1	30
	8491238S		3283460059390	Coude femelle-femelle 45° - Ø 100	HCT44	1	50
	8491252K		3283460059444	Coude femelle-femelle 67°30 - Ø 100	HCT66	1	45
	8491268M		3283460059512	Coude femelle-femelle 87°30 - Ø 100	HCT88	1	35
Coudes femelle-femelle SFC/Jardibric							
	8921088C		3283460080677	Coude femelle-femelle 20° - Ø 100 – SFC		1	12
	8921108F		3283460078469	Coude femelle-femelle 45° - Ø 100 – SFC – <i>NF</i>		1	48
	8921128T		3283460078483	Coude femelle-femelle 67°30 - Ø 100 – SFC – <i>NF</i>		1	20
	8921148G		3283460078537	Coude femelle-femelle 87°30 - Ø 100 – SFC – <i>NF</i>		1	35
Culottes mâle-femelle Nicoll							
	8490152A		3283460058843	Culotte mâle-femelle 45° - Ø 100	HBT14	1	25
	8490168C		3283460069979	Culotte mâle-femelle 67°30 - Ø 100	HBT16	1	30
	8490182U		3283460058904	Culotte mâle-femelle 87°30 - Ø 100	HBT18	1	30
Culottes et tés mâle-femelle SFC/Jardibric							
	8921208L		3283460078582	Culotte mâle-femelle 45° - Ø 100 – SFC		1	30
	8921248M		3283460078612	Tés mâle-femelle 87°30 - Ø 100 – SFC – <i>NF</i>		1	20





TUBES ET RACCORDS EVACUATION DIAMETRE 100

Figure	C. Jardibric	Réf client	Gencod	Désignation	Référence	Cdt	Sur-emb
Culottes femelle-femelle Nicoll							
	8491352Q		3283460059604	Culotte femelle-femelle 45° - Ø 100	HBT144	1	25
	8491368S		3283460071767	Culotte femelle-femelle 67°30 - Ø 100	HBT166	1	25
	8491382K		3283460059666	Culotte femelle-femelle 87°30 - Ø 100	HBT188	1	22
Culottes et tés femelle-femelle SFC/Jardibric							
	8921268A		3283460080738	Culotte femelle-femelle 45° - Ø 100 – SFC		1	30
	8921288N		3283460080752	Culotte femelle-femelle 67°30 - Ø 100 – SFC		1	25
	8921308R		3283460078667	Tés femelle-femelle 87°30 - Ø 100 – SFC – NF		1	24
Manchons – Manchettes – Coulisse Nicoll							
	8491178N		3283460059727	Manchon femelle-femelle à butée – Ø 100	HM2T	1	80
	8492008R		3283460069948	Manchette mâle-femelle – Ø 100	HZT	1	35
	8491022E		3283460059239	Manchette de réparation Ø 100x93	HZTT	1	50
	8492322A		3283460071811	Coulisse femelle-femelle – Ø 100	HKT	1	35
	8490208T		3283460058966	Manchon de dilatation mâle-femelle – Ø 100	HMT	1	50
Manchons – Manchettes – Coulisse SFC/Jardibric							
	8921388T		3283460078698	Manchon femelle-femelle à butée – Ø 100 – SFC – NF		1	18
	8921508C		3283460080820	Manchette de réparation Ø 100x93 – SFC		1	20
	8921448Y		3283460080790	Manchon de dilatation mâle-femelle-Ø 100–SFC		1	10
Bouchons Nicoll							
	8491008M		3283460059192	Bouchon de dégorgeement Ø 100	HFT	1	50
Bouchons SFC/Jardibric							
	8921428K		3283460078759	Bouchon de dégorgeement Ø 100 – SFC		1	50
Réductions Nicoll							
	8490528Y		3283460059123	Tampon de réduction simple Ø 100x32	HT3	1	45
	8490529F		3283460059116	Tampon de réduction simple Ø 100x40	HT4	1	45
	8490712G		3283460059147	Tampon réduction double Ø 100x40x40	HT44	1	45
	8492330R		3283460071842	Tampon réduction double Ø 93,6x40x40	HTT4	1	45
	8490530T		3283460059109	Tampon de réduction simple Ø 100x50	HT5	1	45
	8490533R		3283460059093	Tampon de réduction simple Ø 100x80	HT8	1	45
	8490333F		3283460059031	Réduct extérieure excentrée Ø 100x80	HIT2	1	20
	8490330H		3283460069863	Réduct extérieure excentrée Ø 100x50	HIT5	1	
	8490329U		3283460059048	Réduct extérieure excentrée Ø 100x40	HIT6	1	
Réductions SFC/Jardibric							
	<u>8923005L</u>		<u>3283460080486</u>	<u>Tampon simple/double Ø 93x40x40 – SFC</u>	<u>nouveauté</u>	<u>1</u>	<u>20</u>
	8922213J		3283460078834	Tampon simple/double Ø 100x40x40 – SFC		1	20
	8922215Z		3283460078841	Tampon de réduction simple Ø 100x50 – SFC		1	20
	8922044A		3283460078827	Tampon de réduction simple Ø 100x80 – SFC		1	20
	8921644D		3283460078810	Réduct extérieure excentrée Ø 100x80 – SFC		1	40
	8921636M		3283460080158	Réduct extérieure excentrée Ø 100x40 – SFC		1	25

TUBES ET RACCORDS EVACUATION DIAMETRE 125

Figure	C. Jardibric	Réf client	Gencod	Désignation	Référence	Cdt	Sur-emb
Tubes PVC évacuation NFE NFM1							
	7110171X		3283460040947	Barre de 1 ml tube PVC Ø 125 - <i>NFE - NFM1</i>		5	85
	7110173M		3283460040954	Barre de 2 ml tube PVC Ø 125 - <i>NFE - NFM1</i>		3	85
	7110177S		3283460040978	Barre de 4 ml tube PVC Ø 125 - <i>NFE - NFM1</i>		3	85
Tubes PVC évacuation M1							
	7111171B		3283460079237	Barre de 1 ml tube PVC Ø 125 - <i>MI</i>		5	94
	7111173R		3283460055521	Barre de 2 ml tube PVC Ø 125 - <i>MI</i>		3	94
	7111177X		3283460055538	Barre de 4 ml tube PVC Ø 125 - <i>MI</i>		3	94
Coudes mâle-femelle Nicoll							
	8490040Y		3283460058638	Coude mâle-femelle 45° - Ø 125	HCX4	1	40
	8490054K		3283460058690	Coude mâle-femelle 67°30' - Ø 125	HCX6	1	30
	8490070S		3283460058751	Coude mâle-femelle 87°30' - Ø 125	HCX8	1	25
Coudes mâle-femelle SFC/Jardibric							
	8921031R		3283460078346	Coude mâle-femelle 45° - Ø 125 - SFC - <i>NF</i>		1	28
	8921051E		3283460080134	Coude mâle-femelle 67°30' - Ø 125 - SFC		1	25
	8921071S		3283460078414	Coude mâle-femelle 87°30' - Ø 125 - SFC		1	30
Coudes femelle-femelle Nicoll							
	8491240N		3283460059406	Coude femelle-femelle 45° - Ø 125	HCX44	1	30
	8491254A		3283460059468	Coude femelle-femelle 67°30' - Ø 125	HCX66	1	25
	8491270H		3283460059529	Coude femelle-femelle 87°30' - Ø 125	HCX88	1	20
Coudes femelle-femelle SFC/Jardibric							
	8921111J		3283460080684	Coude femelle-femelle 45° - Ø 125 - SFC		1	25
	8921151K		3283460080691	Coude femelle-femelle 87°30' - Ø 125 - SFC		1	20
Culottes mâle-femelle Nicoll							
	8490154Q		3283460058850	Culotte mâle-femelle 45° - Ø 125	HBX14	1	16
	8490184K		3283460058911	Culotte mâle-femelle 87°30' - Ø 125	HBX18	1	16
Culottes mâle-femelle SFC/Jardibric							
	8921211P		3283460078599	Culotte mâle-femelle 45° - Ø 125 - SFC		1	16
	8921251Q		3283460078629	Culotte mâle-femelle 87°30' - Ø 125 - SFC		1	15
Culottes femelle-femelle Nicoll							
	8491354F		3283460059611	Culotte femelle-femelle 45° - Ø 125	HBX144	1	14
	8491384A		3283460059673	Culotte femelle-femelle 87°30' - Ø 125	HBX188	1	15
Culottes femelle-femelle SFC/Jardibric							
	8921271D		3283460080745	Culotte femelle-femelle 45° - Ø 125 - SFC		1	12
	8921311U		3283460080769	Culotte femelle-femelle 87°30' - Ø 125 - SFC		1	15
Manchons - Bouchons Nicoll							
	8491184P		3283460059734	Manchon femelle-femelle à butée - Ø 125	HM2X	1	20
	8491010H		3283460059208	Bouchon de dégorgement Ø 125	HFX	1	35

TUBES ET RACCORDS EVACUATION DIAMETRE 125

Figure	C. Jardibric	Réf client	Gencod	Désignation	Référence	Cdt	Sur-emb
Manchons – Bouchons SFC/Jardibric							
	8921391X		3283460078704	Manchon femelle-femelle à butée – Ø 125 – SFC		1	40
	8921451B		3283460080806	Manchon de dilatation mâle-femelle-Ø 125 – SFC		1	15
	8921431N		3283460078766	Bouchon de dégorgement Ø 125 – SFC		1	35
Réductions Nicoll							
	8490552X		3283460059130	Tampon de réduction simple Ø 125x100	HX10	1	25
	8490352L		3283460059055	Réduction extérieure excentrée Ø 125x100	HIX2	1	25
Réductions SFC/Jardibric							
	8922074U		3283460080844	Tampon de réduction simple Ø 125x100 – SFC		1	25
	8921674Y		3283460080837	Réduction extérieure excentrée Ø 125x100 – SFC		1	60
Siphon Nicoll							
	8191756L		3309030470102	Siphon disconnecteur Ø 125	YDX	2	
Accessoire divers Nicoll							
	8353520K		3309030491404	Colliers à bride Ø 125	UCOX	10	100
Accessoire divers SFC/Jardibric							
	8925516L		3283460080110	Colliers PVC avec clips Ø 125 - SFC		10	50